

## OPERATING AND INSTALLATION INSTRUCTIONS

### Models: B250, B300, B750, B1000, B1500, B2000, B3000, B4000

#### **SAFETY INSTRUCTIONS**

1. **WARNING** – To avoid risk of injury, do not operate the unit unless properly installed to the busboy cone or mounting flange specified in the instructions.
2. Installation of disposers must be performed by qualified personnel.
3. Please read instructions before installing and using this appliance.
4. When using electrical appliances, basic precautions should always be followed to reduce the risk of fire, electric shock and injury.

#### **INSTALLATION – B250 DISPOSER**

1. The sink mount comes already assembled in the proper order. To install to the sink, the sink flange must be removed.
2. Remove the three nuts to separate the sink mount from the disposer.
3. Loosen the three adjusting screws until the snap ring becomes exposed and remove it from the sink flange.
4. Remove the sink flange and drop it down through the sink opening making sure to seal it properly with appropriate sealant.
5. Assemble the sink flange to the sink mount and back to the disposer in the reverse order.
6. Check for leaks.
7. Wire the unit following the appropriate schematic on the following pages. Use wire suitable for 90°C minimum.

#### **INSTALLATION – ALL OTHER DISPOSERS**

1. If installing to an existing cone, an adapter kit may be needed. Call customer service for proper sizing. Installation instructions will be provided with the adapter kit.
2. If new installation, a cone or sink flange will need to be welded into the sink for mounting. Consult parts list for available flanges.
3. Once a flange has been welded into the sink, the disposer is mounted to the bottom of it.
4. Place the slotted gasket over the top of the disposer hopper so that the holes line up. Raise it up to the sink flange.
5. If the disposer is provided with the three support posts, loosen the set screw and drop the legs to the floor to support the disposer and then tighten the set screws back again.
6. Place the (3) adapter segments over the sink flange so that the holes line up with the holes in the hopper.
7. Place the (6) screws down through the segments and into the hopper. Tighten the screws and check for leaks.
8. A water line must be plumbed to the disposer's hopper making sure the minimum water requirements are met as listed below.  
 $\frac{1}{2}$  HP require 2 gpm / 1 HP require 3 gpm /  $1\frac{1}{2}$  - 3 HP require 5 gpm / 4 HP and up require 8 gpm
9. Wire the unit following the appropriate schematic on the following pages. Use wire suitable for 90°C minimum.

#### **OPERATION**

1. This disposer is designed to accommodate food waste only, do not place any trash in the disposer. Do not place any foam, wood, foil, rubber, glass, or clothes in the disposer as these will jam the machine.
2. Greases, oils, and drain cleaners will damage the gaskets and should also be avoided.
3. Some foods wastes can damage the disposer and should not be ran through it. These are large whole bones, clam or oyster shells, and whole corn husks.
4. Turn on the disposer and make sure water is running into the hopper before feeding any food into the drain. Feeding food into the disposer before turning it on may cause the unit to jam.
5. Be sure all food waste has been disposed before turning the disposer off.
6. If a time delay relay is being used, it must be set for a cycle of not less than two minutes. This makes sure all food has been flushed through the drain and minimizes the risk of a stoppage.

#### **MAINTENANCE**

1. Wipe the disposer down with a damp cloth daily, do not spray the unit down with water as this will damage the motor.
2. Check the cutting table wear once a month. As the cutting table wears, the disposer will allow larger food to pass through the drain. If the wear becomes excessive, a stoppage may occur.
3. If the cutting table has a visible gap between it and the cutting sleeve, then it is time to rebuild the disposer.

#### **TROUBLESHOOTING**

Motor Not Turning	Turn power off. Check to make sure motor is not jammed. With the power off, motor should turn freely
	Turn the Power off. Check for a faulty switch, reversing switch, solenoid valve, or contactor. (This should be done by qualified personnel or service technicians only)
	Press the reset button located on the junction box on the motor
	Check the circuit breaker to make sure it is operational
Motor Does Not Stop Turning	In a situation that the motor does not stop turning, disconnect power from the motor to prevent damage to the motor. This may require turning the circuit breaker off. Have a service agent or qualified personnel check for a faulty switch, reversing switch, solenoid valve, or contactor.

**WIRING SCHEMATICS**

SINGLE PHASE WIRING DIAGRAM FOR PUSH/PULL SWITCH OR MANUAL CONTACTORS

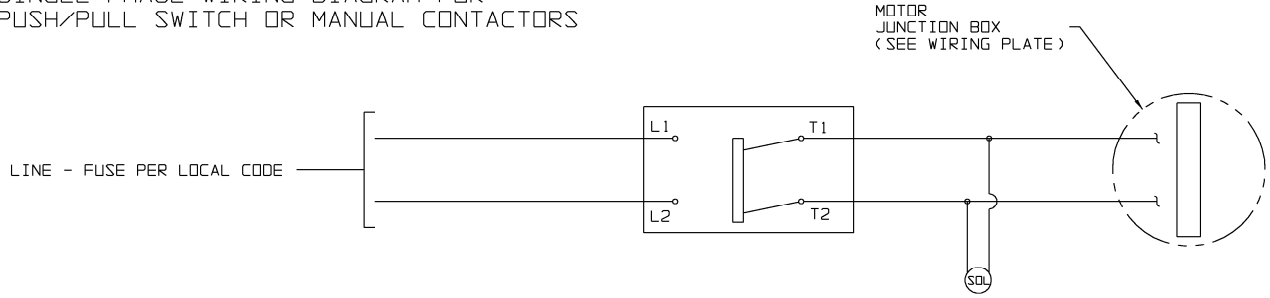

SINGLE PHASE 115V WIRING DIAGRAM FOR REVERSING SWITCH AND SOLENOID VALVE

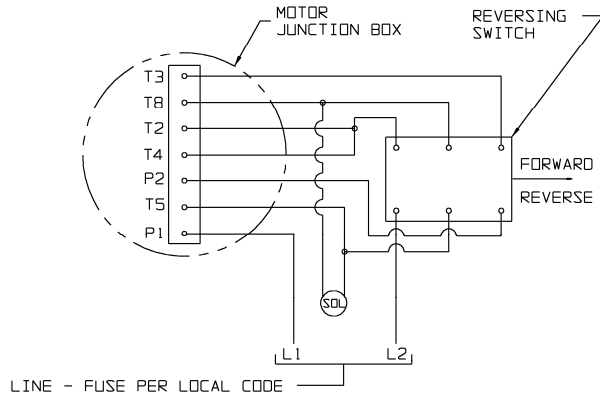

SINGLE PHASE 230V WIRING DIAGRAM FOR REVERSING SWITCH AND SOLENOID VALVE

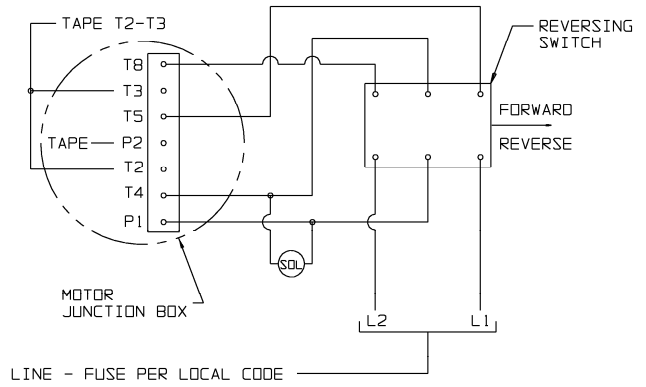

SINGLE PHASE 115V WIRING DIAGRAM FOR REVERSING SWITCH AND TIME DELAY RELAY

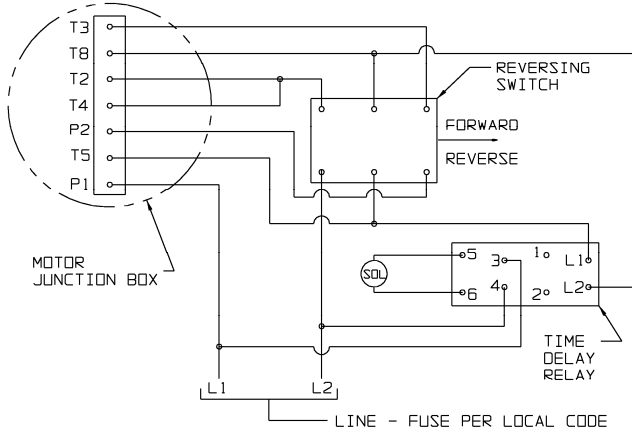

SINGLE PHASE 230V WIRING DIAGRAM FOR REVERSING SWITCH AND TIME DELAY RELAY

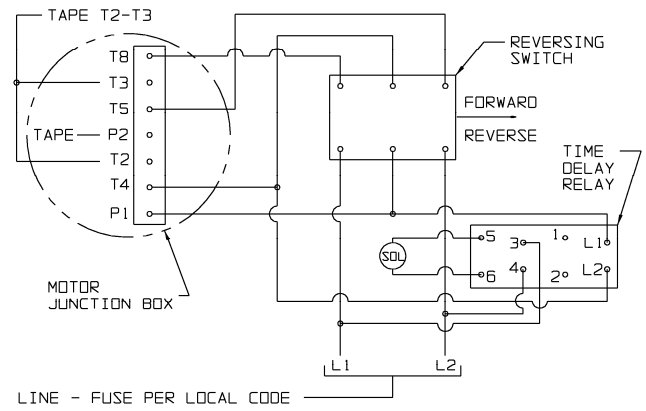

SINGLE AND THREE PHASE WIRING FOR MAGNETIC CONTACTOR

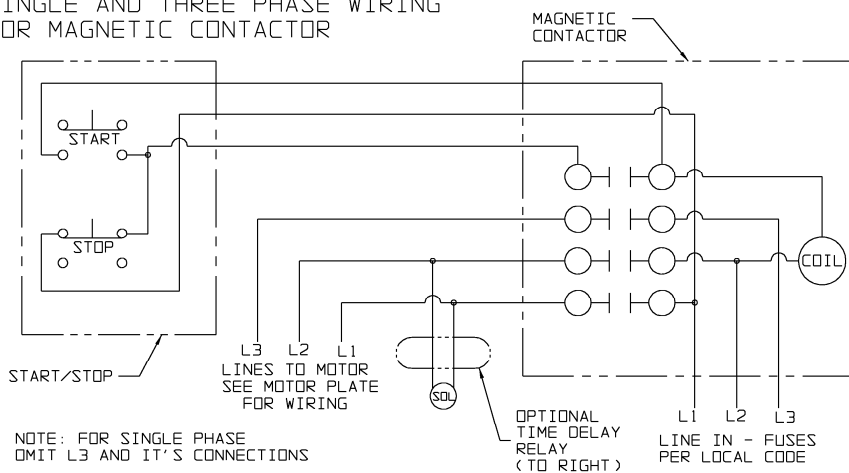

WIRING TIME DELAY RELAY WITH MAGNETIC CONTACTOR

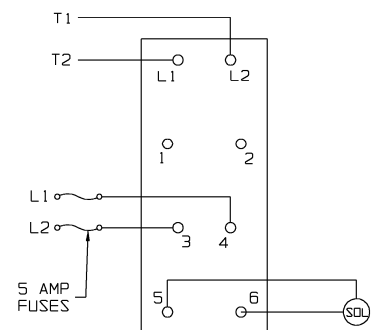

THREE PHASE WIRING DIAGRAM FOR  
PUSH/PULL SWITCH OR MANUAL CONTACTORS

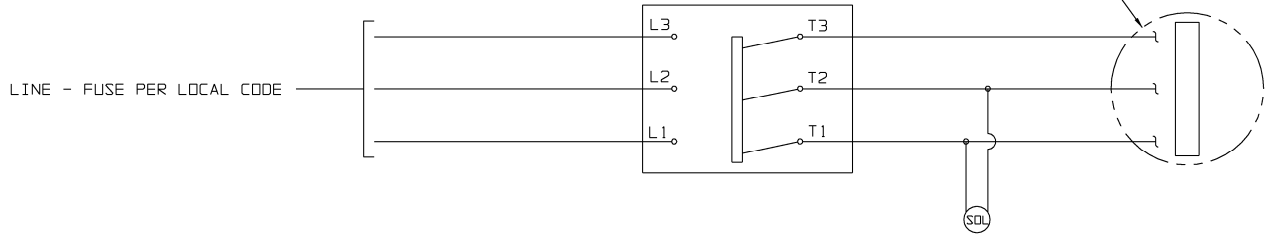

THREE PHASE 220V WIRING DIAGRAM FOR  
REVERSING SWITCH AND SOLENOID VALVE

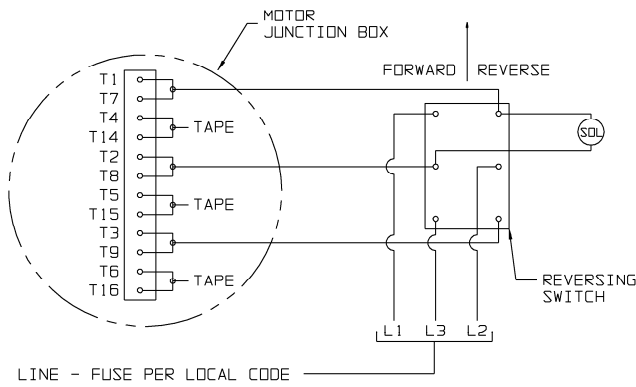

THREE PHASE 440V WIRING DIAGRAM FOR  
REVERSING SWITCH AND SOLENOID VALVE

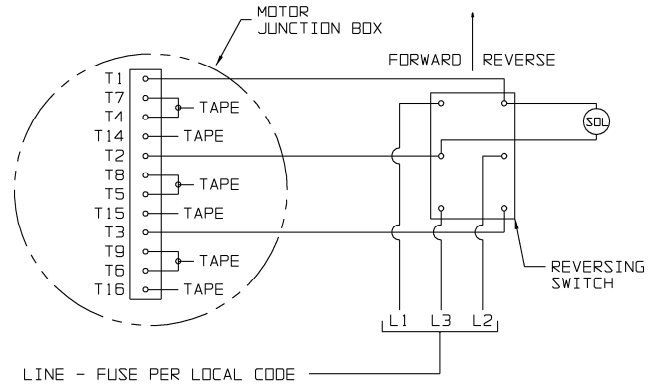

THREE PHASE 220V WIRING DIAGRAM FOR  
REVERSING SWITCH AND TIME DELAY RELAY

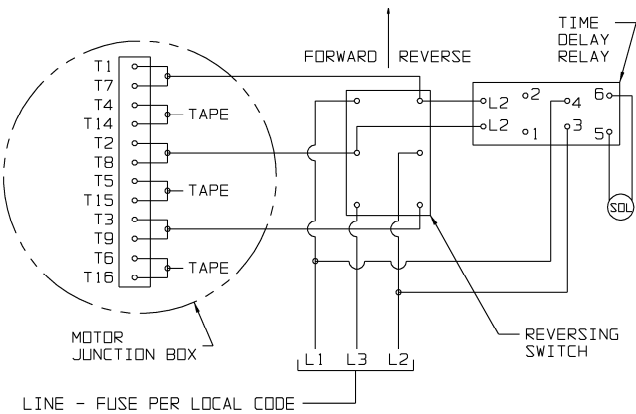

THREE PHASE 440V WIRING DIAGRAM FOR  
REVERSING SWITCH AND TIME DELAY RELAY

